

# ENGINE/ PUMP ADAPTERS

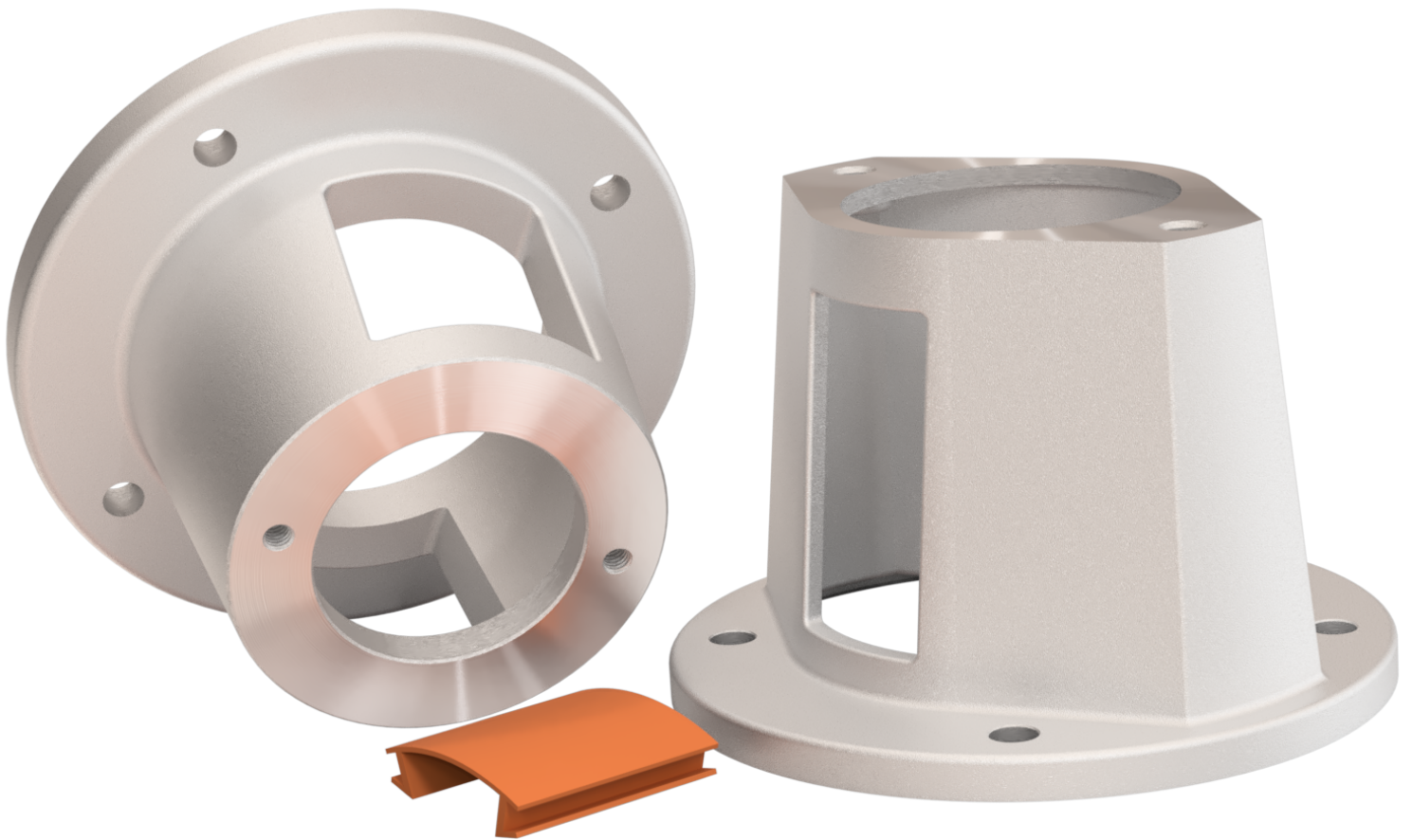

**Hayes Manufacturing, Inc.**

6875 US Highway 131

Fife Lake, MI 49633

Phone: 231-879-3372 | Fax: 231-879-4330

[www.hayescouplings.com](http://www.hayescouplings.com)

**HAYES**<sup>®</sup>

We've Got Connections

POWER  
TRANSMISSION  
PRODUCTS

**Hayes Manufacturing, Inc.**  
6875 US Highway 131  
Fife Lake, MI 49633  
Phone: 231-879-3372 | Fax: 231-879-4330  
www.hayescouplings.com



## Table Of Contents

Engine/Pump Mount Part Number Selection	3
Engine Mount Selection Chart "G" Series	4-9
Special Application Engine Mounts	10
Engine Mount Selection Chart "GM" Series (Metric)	11
Foot Mount Brackets "FM" Series	12
Electric Mount Selection Chart "E" Series	13-17
Vertical Electric Mount Selection Chart "V" Series	17-18
Vertical Adapter Rings	19
Assembly Aid	19
SAE- 2 Bolt And SAE- 4 Bolt Mounting Flange Dimensions	20
NEMA Electric Motor "C" Face Motor Dimensions	21

**ENGINE/PUMP MOUNT PART NUMBER SELECTION**

**EXAMPLE:**

**G 16-134 6.00 XXX**

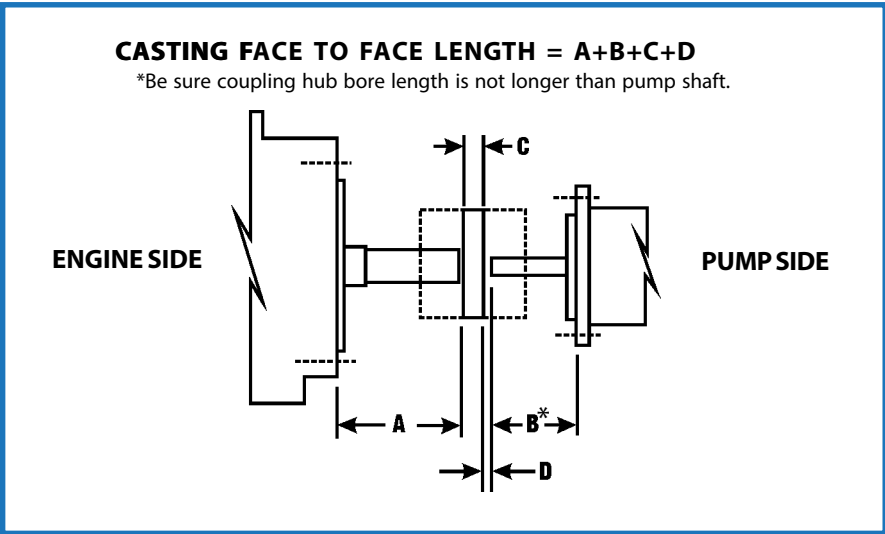
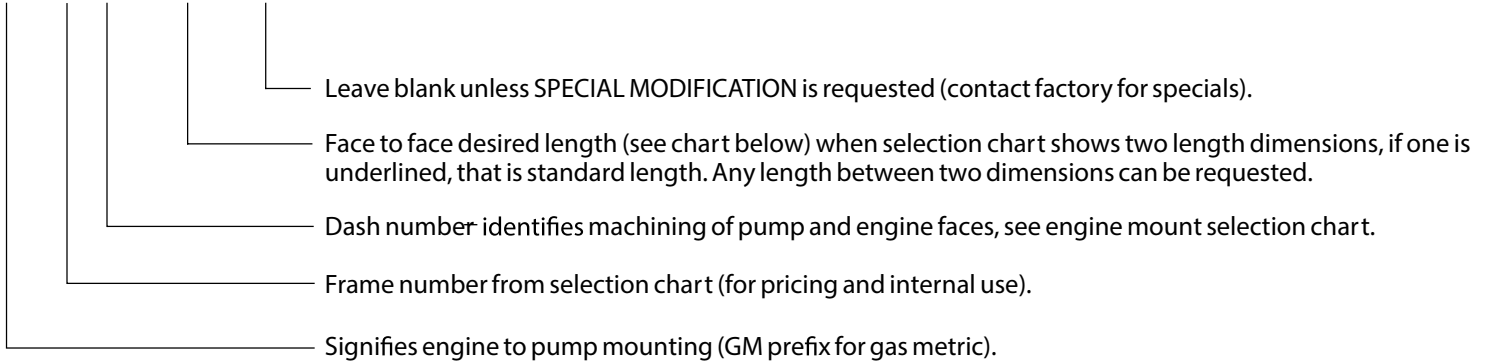

The above dimensional information must be obtained from actual measurement or from engine, pump, and coupling manufacturers catalog.

- A**- Engine shaft length including pilot depth to engine block.
- B\***- Pump shaft length including pilot depth to pump flange mounting face. (In some applications this can be coupling hub bore length if pump shaft is short).
- C**- Width of flexible coupling insert.
- D**- Clearance as required, normally 1/16" to 1/2".

- Note:**
1. If shaft and coupling stack up does not provide for "D" clearance, consideration should be made to shorten engine shaft or select a shaft coupling with thru hole in insert for shaft clearance.
  2. All 2 bolt pump mounting holes are horizontal unless requested for other position.

**Safety Note:**  
 In locations where coupling access is not covered or where body, loose clothing or equipment may be exposed to rotating coupling, this cover must be used.

Part number of access cover is listed with each mount number along with quantity required.

**ENGINE MOUNT SELECTION CHART "G" SERIES**

Frame Number	Pump Flange	Engine Data		
		Bolt Circle 3 <sup>1</sup> / <sub>8</sub> " Pilot Diameter (none) 1.780 Clearance Diameter	Bolt Circle 3 <sup>1</sup> / <sub>8</sub> " Pilot Diameter 1.625	Bolt Circle 6 <sup>1</sup> / <sub>2</sub> " Pilot Diameter 5.750

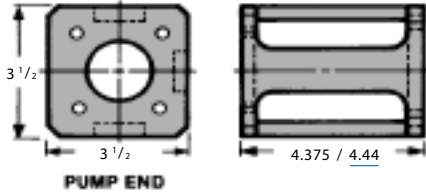

**Mount Basic Data**  
 Access Cover AC10 (1 Required)  
 Maximum Coupling Diameter 2-1/2"  
 Approximate Weight 1 lb. 3 oz.

10	4F17	-101	-102	
----	------	------	------	--

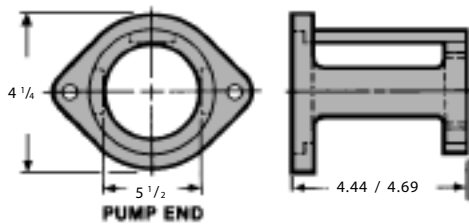

**Mount Basic Data**  
 Access Cover AC11 (1 Required)  
 Maximum Coupling Diameter 2-1/2"  
 Approximate Weight 1 lb. 6 oz.  
**Standard Lengths**  
 4.44 SAE A 2 Bolt  
 4.69 SAE A 2 Bolt

11	SAE A A 2 Bolt	-105	-106	
	SAE A 2 Bolt	-107	-108	

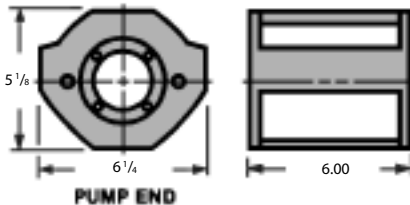

**Mount Basic Data**  
 Access Cover AC12 (1 Required)  
 Maximum Coupling Diameter 4"  
 Approximate Weight 2 lb. 11 oz.

12	SAE A 2 Bolt	-109	-110	
----	--------------	------	------	--

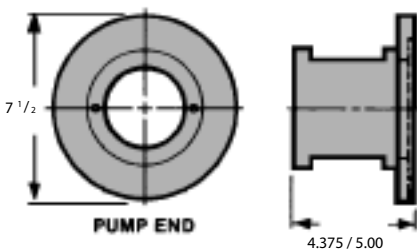

**Mount Basic Data**  
 Access Cover AC13 (2 Required)  
 Maximum Coupling Diameter 3-1/2"  
 Approximate Weight 3 lb. 2 oz. SAE A 4 Bolt available  
 Heavy casting, similar to G300

13	4F17*			-111
	SAE A A 2 Bolt			-112
	SAE A 2 Bolt			-113

\*Will accept coupling assembly aid- see page 19 for explanation.

**ENGINE MOUNT SELECTION CHART "G" SERIES CONTINUED**

Frame Number	Pump Flange	Engine Data		
		Bolt Circle 3 <sup>5</sup> / <sub>8</sub> " Pilot Diameter (none) 1.780 Clearance Diameter	Bolt Circle 3 <sup>5</sup> / <sub>8</sub> " Pilot Diameter 1.625	Bolt Circle 6 <sup>1</sup> / <sub>2</sub> " Pilot Diameter 5.750

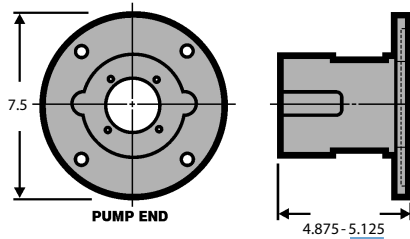

**Mount Basic Data**

Access Cover AC300 (2 Required)  
 Maximum Coupling Diameter 3-1/2"  
 Approximate Weight 2 lb. 2 oz. Available with no cover openings

300	4F17*			-400
	SAE AA 2 Bolt			-401
	SAE A 2 Bolt			-402

\*May replace the 13 Frame on light to medium duty applications.

\*Will accept coupling assembly aid- see page 18 for explanation.

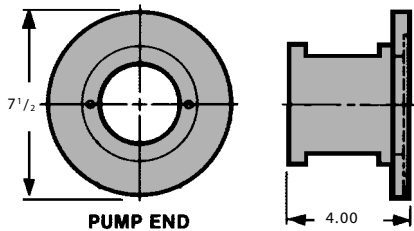

**Mount Basic Data**

Access Cover AC14 (2 Required)  
 Maximum Coupling Diameter 3-1/2"  
 Approximate Weight 2 lb. 2 oz.

14	4F17*			-114
	SAE AA 2 Bolt			-115
	SAE A 2 Bolt			-116

\*Will accept coupling assembly aid- see page 18 for explanation.

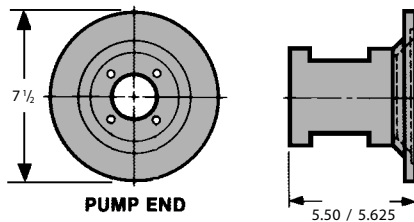

**Mount Basic Data**

Access Cover AC15 (2 Required)  
 Maximum Coupling Diameter 3"  
 Approximate Weight 3 lb. 1 oz.

15	4F17*			-117
	SAE A A 2 Bolt			-118

\*Will accept coupling assembly aid- see page 19 for explanation.

**ENGINE MOUNT SELECTION CHART "G" SERIES**

Frame Number	Pump Flange	Engine Data						
		Bolt Circle 6 1/2" Pilot 5 1/4"	Bolt Circle 7 1/4" Pilot 7"	Bolt Circle 7 1/4" Pilot 7"	Bolt Circle 7 1/4" Pilot 7"	Bolt Circle 7 1/4" Pilot 6 1/16"	Bolt Circle 7 1/4" Pilot 6 1/16" 7" Option B&S 10hp Cast Iron	Bolt Circle 7 1/4" Pilot 6 1/16" 7" Option B&S 16hp Cast Iron
				Wisconsin TJD	Wisconsin AENL			

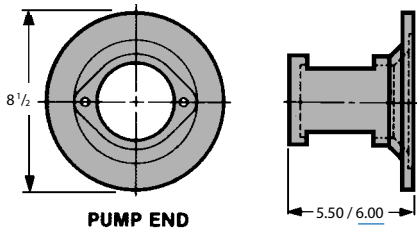

**Mount Basic Data**  
 Access Cover AC16 (2 Required)  
 Maximum Coupling Diameter 3-1/4"  
 Approximate Weight 4 lb. 5 oz. Available with no cover openings

16	4F17*	-119	-120	-122	-123	-124	-125	-126
	SAE AA 2 Bolt	-127	-128	-129	-130	-131	-132	-133
	SAE A 2 Bolt	-134	-135	-136	-137	-138	-139	-140

\*Will accept coupling assembly aid- see page 18 for explanation.

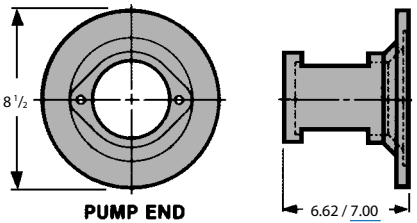

**Mount Basic Data**  
 Access Cover AC17 (2 Required)  
 Maximum Coupling Diameter 3-1/4"  
 Approximate Weight 4 lb. 15 oz.

17	SAE A 2 Bolt	-141	-142	-143	-144	-145	-146	-147
----	--------------	------	------	------	------	------	------	------

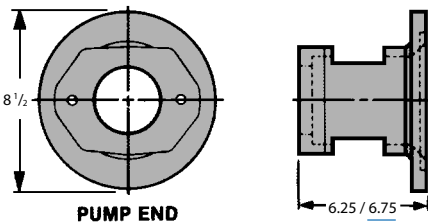

**Mount Basic Data**  
 Access Cover AC18 (2 Required)  
 Maximum Coupling Diameter 3-7/8"  
 Approximate Weight 7 lb. 8 oz. SAE A 4 Bolt Available

18	SAE A 2 Bolt	-148	-149	-150	-151	-152	-153	-154
	SAE B 2 Bolt	-155	-156	-157	-158	-159	-160	-161
	SAE B 4 Bolt	-162	-163	-164	-165	-166	-167	-168

**ENGINE MOUNT SELECTION CHART "G" SERIES CONTINUED**

Frame Number	Pump Flange	Engine Data						
		Bolt Circle 6 1/2" Pilot 5 3/4"	Bolt Circle 7 1/4" Pilot 7"	Bolt Circle 7 1/4" Pilot 7"	Bolt Circle 7 1/4" Pilot 7"	Bolt Circle 7 1/4" Pilot 6 1/16"	Bolt Circle 7 1/4" Pilot 6 1/16" 7" Option B&S 10hp Cast Iron	Bolt Circle 7 1/4" Pilot 6 1/16" 7" Option B&S 16hp Cast Iron
				Wisconsin TJD	Wisconsin AENL			

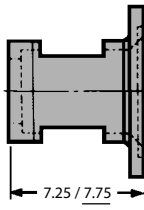
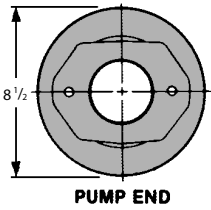

**Mount Basic Data**

Access Cover AC19 (2 Required)  
 Maximum Coupling Diameter 3 7/8"  
 Approximate Weight 8 lb.  
 SAE A 4 Bolt Available

19	SAEA 2 Bolt	-169	-170	-171	-172	-173	-174	-175
	SAEB 2 Bolt	-176	-177	-178	-179	-180	-181	-182
	SAEB 4 Bolt	-183	-184	-185	-186	-187	-188	-189

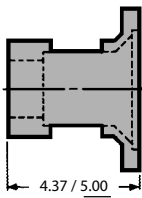
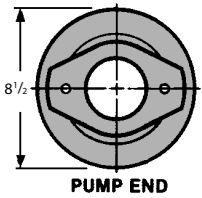

**Mount Basic Data**

Access Cover AC20 (2 Required)  
 Maximum Coupling Diameter 3 7/8"  
 Approximate Weight 5 lb. 3 oz.

20	SAEA 2 Bolt	-403	-404	-405	-406	-407	-408	-409
	SAEB 2 Bolt	-190	-191	-192	-193	-194	-195	-196

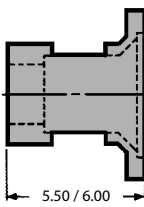
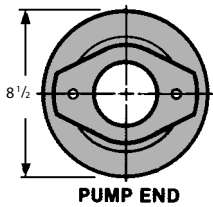

**Mount Basic Data**

Access Cover AC21 (2 Required)  
 Maximum Coupling Diameter 3 7/8"  
 Approximate Weight 5 lb. 2 oz.  
 SAE A 4 Bolt Available

21	SAEA 2 Bolt	-197	-198	-199	-200	-201	-202	-203
	SAEB 2 Bolt	-204	-205	-206	-207	-208	-209	-210

**ENGINE MOUNT SELECTION CHART "G" SERIES CONTINUED**

Frame Number	Pump Flange	Engine Data			
		Bolt Circle 8 <sup>5</sup> / <sub>8</sub> " Pilot 7 <sup>7</sup> / <sub>8</sub> "	Bolt Circle 9 <sup>1</sup> / <sub>4</sub> " Pilot 7 <sup>7</sup> / <sub>8</sub> "	Bolt Circle 9 <sup>1</sup> / <sub>4</sub> " Pilot 8 <sup>1</sup> / <sub>4</sub> "	Bolt Circle ONAN Pilot 6 <sup>3</sup> / <sub>8</sub> "

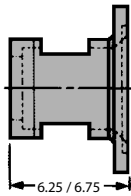
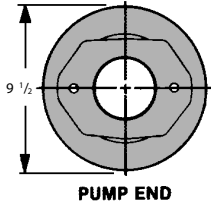

**Mount Basic Data**  
 Access Cover AC22 (2 Required)  
 Maximum Coupling Diameter 3<sup>7</sup>/<sub>8</sub>"  
 Approximate Weight 8 lb. 3 oz.  
 SAE A 4 Bolt Available

22	SAEA 2 Bolt	-211			
	SAEB 2 Bolt	-212			
	SAEB 4 Bolt	-213			

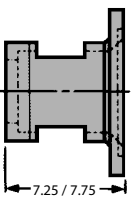
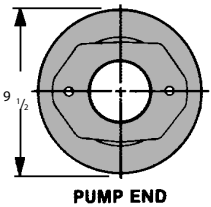

**Mount Basic Data**  
 Access Cover AC23 (2 Required)  
 Maximum Coupling Diameter 3<sup>7</sup>/<sub>8</sub>"  
 Approximate Weight 8 lb. 13 oz.  
 SAE A 4 Bolt Available

23	SAEA 2 Bolt	-214			
	SAEB 2 Bolt	-215			
	SAEB 4 Bolt	-216			

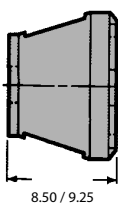
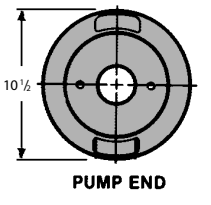

**Mount Basic Data**  
 Access Cover AC24 (2 Required)  
 Maximum Coupling Diameter 7"  
 Approximate Weight 16 lb. 7 oz.  
 SAE A 4 Bolt Available

24	SAEA 2 Bolt	-217	-218	-219	
	SAEB 2 Bolt	-220	-221	-222	
	SAEB 4 Bolt	-223	-224	-225	



**ENGINE MOUNT SELECTION CHART "G" SERIES CONTINUED ONAN/LINAMAR ENGINES**

Frame Number	Pump Flange	Engine Data			
		Bolt Circle 8 <sup>5</sup> / <sub>8</sub> " Pilot 7 <sup>1</sup> / <sub>8</sub> "	Bolt Circle 9 <sup>1</sup> / <sub>4</sub> " Pilot 7 <sup>1</sup> / <sub>8</sub> "	Bolt Circle 9 <sup>3</sup> / <sub>4</sub> " Pilot 8 <sup>1</sup> / <sub>4</sub> "	Bolt Circle ONAN Pilot 6 <sup>3</sup> / <sub>8</sub> "

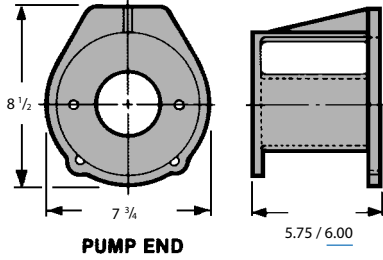

**Mount Basic Data**

Access Cover AC25 (2 required)  
 Maximum Coupling Diameter 5<sup>1</sup>/<sub>2</sub>"  
 Approximate Weight 4 lb. 10 oz.  
 SAE B 2 or 4 Bolt Available  
 SAE A 4 Bolt Available

25	4F17				-226
	SAE AA 2 Bolt				-227
	SAE A 2 Bolt				-228

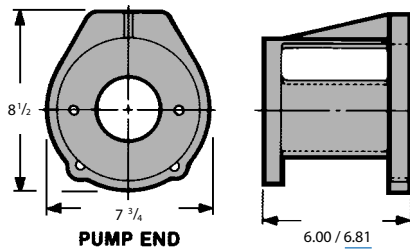

**Mount Basic Data**

Access Cover AC26 (2 Required)  
 Maximum Coupling Diameter 5<sup>1</sup>/<sub>2</sub>"  
 Approximate Weight 6 lb. 3 oz.  
 SAE A 4 Bolt Available

26	SAE A 2 Bolt				-229
	SAE B 2 Bolt				-230
	SAE B 4 Bolt				-231

**SPECIAL APPLICATION ENGINE MOUNTS "G" SERIES CONTINUED**

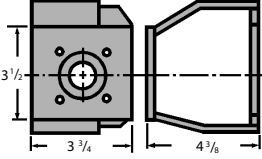
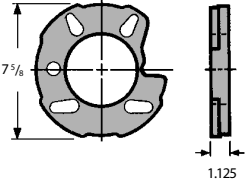
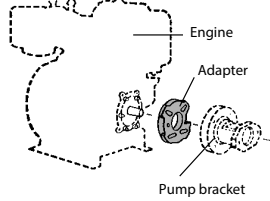
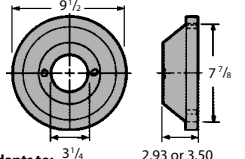
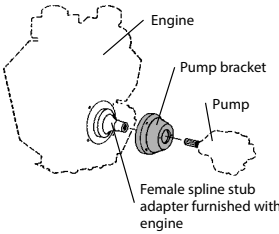
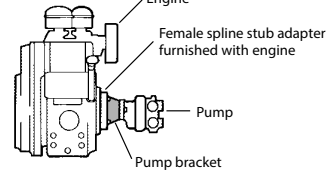
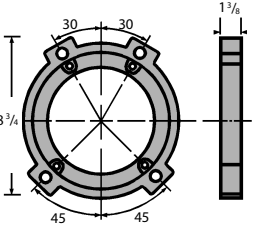
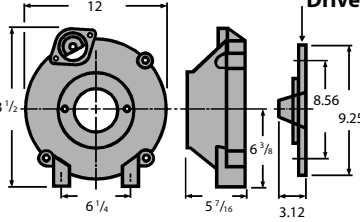
Approximate Weight	Frame Number		Dash Number For Part Number		
1 lb. 9 oz.	27	AC 27 Access cover (2 required)		-232	Engine bolt circle 5 1/8", pilot dia. none, clearance dia. 1.780.
		Designed with space for 2 1/2" dia. pulley to belt drive auxiliary equipment. Fits 4F17 pump.		-233	Engine bolt circle 5 3/8", pilot dia. 1.625.
1 lb. 12 oz.	28			-234	Adapts Wisconsin WD1 and WD2 diesel engines to pump mount for 7 3/4" B.C. and 7" pilot engine mounts.
4 lb. 9 oz.	29			-235	 <p>Assembly instructions furnished with pump engine mount</p>
5 lb. 2 oz.	30	<p>Adapts to: 3/4" 2.93 or 3.50</p> <p>Engines Wisconsin W2-1230, W4-1770, W4-2460 and other equipped with female spline stub shaft adapter</p> <p>Pumps SAE "A" 2 bolt pilot</p>	<p>2.93 Length</p> <p>3.50 Length</p>	-236	
2 lb. 5 oz.	31		Adapter to go from 7.00 engine pilot dia. to 5.75 engine pilot dia.	-326	
10 lb.	32		<p><b>Drive Plate</b></p> <p>Drive plate part number 327-1 For 7/8"- 13 spline pump shaft.</p>	-327	Volkswagen drive cover with mount for starter motor fits VW "Bug" engine 4 cyl. opposed model 126 A and others. And SAE B 2 bolt pump

Part Number Order Code: (Example: G 30 -236)

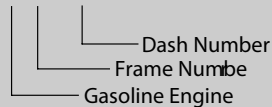

Length code at at end of part number is deleted since length is not an option for frame number 27-32.

**DASH NUMBER FOR: ENGINE MOUNTS FOR METRIC PUMPS "GM" SERIES**

Bolt Circle 3.62	
Pilot Dia. None	Pilot Dia. 1.625

Bolt Circle 6.50	Bolt Circle 7.750			
Pilot Dia. 5.75	Pilot Dia. 6.43	Pilot Dia. 6.43 7" Option B&S 10 & 16 HP C.I. Clearance Holes 5 <sup>5</sup> / <sub>8</sub> " B.C.	Pilot Dia. 7.00 Wisconsin TJD & AENL Clearance Holes 6 <sup>1</sup> / <sub>4</sub> " B.C.	Pilot Dia. 7.00

FRAME 33		
<b>Mount Basic Data</b> Approximate Weight 1 lb. 5 oz. Access Cover A33 (1 Required) Maximum Coupling Dia. 2"		
1	-237	-238
2	-239	-240
3	-241	-242
4	-243	-244
5	-245	-246
6	-247	-248

FRAME 34					
<b>Mount Basic Data</b> Access Cover AC34 (2 Required) Maximum Coupling Dia. 3 <sup>1</sup> / <sub>8</sub> " Approximate Weight 3 lb. 5 oz.					
1	-249	-250	-251	-252	-253
2	-254	-255	-256	-257	-258
3	-259	-260	-261	-262	-263
4	-264	-265	-266	-267	-268
5	-269	-270	-271	-272	-273
6	-274	-275	-276	-277	-278

Pump Flange Dimensions					
Order Code	A	B	C	D	E
1	26.5 1.04"	72 2.83"	52.4 2.08"	25.4 1.0"	M6
2	24.5 .96"	73 2.87"	56 2.20"	30 1.18"	M6
3	32.2 1.27"	96.2 3.78"	71.5 2.81"	36.5 1.43"	M8
4	14.3 .56"	60.4 2.38"	60 2.36"	50 1.97"	M8
5	34.5 1.36"	100 3.94"	72 2.83"	80 3.15"	M8
6	32.2 1.27"	46.2 3.78"	71.5 2.81"	36.5 1.43"	M8

FRAME 35					
<b>Mount Basic Data</b> Access Cover AC35 (2 Required) Maximum Coupling Dia. 3 <sup>1</sup> / <sub>8</sub> " Approximate Weight 3 lb. 10 oz. *Available in 5.43 Length					
1	-279	-280	-281	-282	-283
2	-284	-285	-286	-287	-288
3	-289	-290	-291	-292	-293
4	-294	-295	-296	-297	-298
5	-299	-300	-301	-302	-303
6	-304	-305	-306	-307	-308

Metric Pump Mount Part Number Order Code: (Example: GM 34 -250)

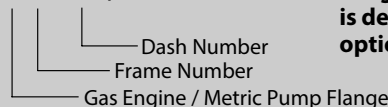

Length code at end of part number is deleted since length is not an option for frame number 33-35.

**FOOT MOUNT BRACKETS FOR HYDRAULIC PUMP AND MOTORS "FM" SERIES**

**FM-36-M3** Foot Mounting Bracket for small gerotor torque motors. Fits Eaton M Series, Danfoss, OMM and other motors with same mounting.

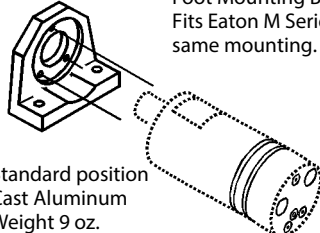

Standard position  
 Cast Aluminum  
 Weight 9 oz.

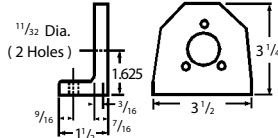

**FM-37-M3R** Foot Mounting Bracket for small gerotor torque motors. Fits Eaton M Series, Danfoss, OMM and other motors with same mounting.

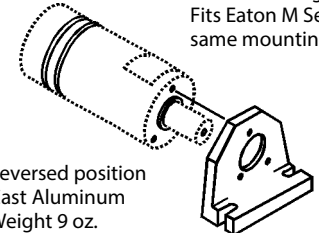

Reversed position  
 Cast Aluminum  
 Weight 9 oz.

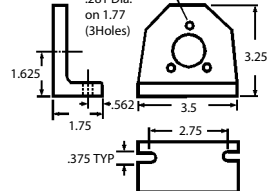

**FM-38 4F** Weight 13 oz.

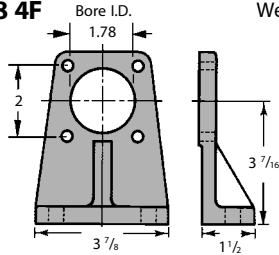

Bore I.D. 1.78  
 2  
 3 7/16  
 1 1/2  
 3 7/16

**FM-39-AA2** Weight 1 lb.

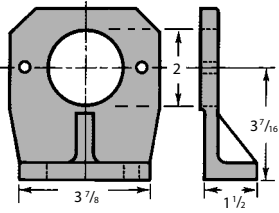

2  
 3 7/16  
 1 1/2  
 3 7/8

**FM-40-A2** Weight 1 lb. 11 oz.

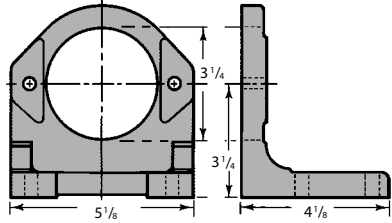

3 1/4  
 3 1/4  
 5 1/8  
 4 1/8

**FM-41-A2C** Weight 2 lb. 1 oz.  
 For electric clutch mounting

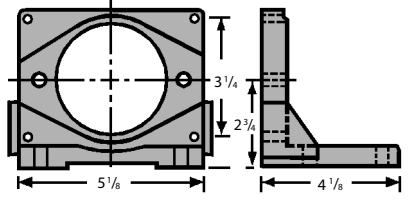

3 3/4  
 2 3/4  
 5 1/8  
 4 1/8

**FM-42-B2** Weight 2 lb. 13 oz.

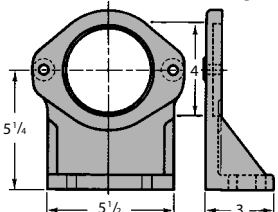

5 1/4  
 4  
 3  
 5 1/2

**Ordering Information**

**Product Type** **FM - 40 - A2**

Foot Mount \_\_\_\_\_  
 Frame Number \_\_\_\_\_  
 Pump Flange \_\_\_\_\_

**HORIZONTAL HYDRAULIC PUMP MOUNTS FOR ELECTRIC MOTORS "E" SERIES**

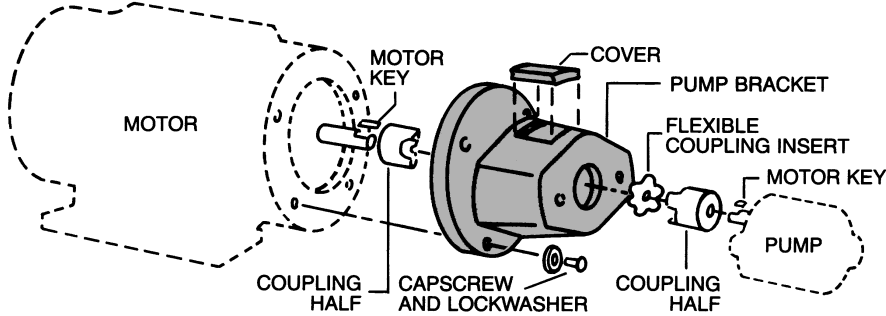

Frame Number	Pump Mount Part Number	Motor Frame Size	SAE Pump Flange	Face To Face	Dimensions Of NEMA-C Face Mount End (inches)			Dimensions Of Pump Face Mount End (inches)		Access Cover Number	Maximum Coupling Diameter
					A	B	Bolt Circle C	D Nominal	Pump Bolt Circle		

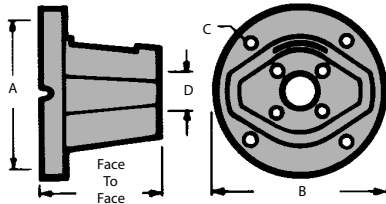

**Mount Basic Data**  
 Approximate Weight  
 Frame 49- 1 lb. 12 oz.

49	E49-A4	56C	4F17	3.50"	4.50	6.625	5.875	1.78	2.83	AC 49	3.00
	E49-AA		AA-2 Bolt					2.00	3.25		
	E49-A2	143-145 TC	A-2 Bolt					3.25	4.188		

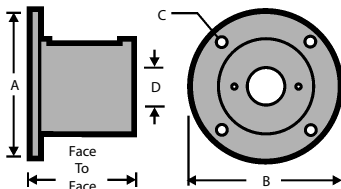

**Mount Basic Data**  
 501 replaces the 50Z  
 For single or light pump applications  
 Access Cover (1 required)  
 Approximate Weight  
 Frame 501- 3 lb.

Available in 4.00 length  
 SAE A 4 Bolt Available

501	E501-A4	56C	4F17	4.25"	4.50	6.625	5.875	1.78	2.83	AC 501	3.50
	E501-AA		AA-2 Bolt					2.00	3.25		
	E501-A2	143-145 TC	A-2 Bolt					3.25	4.188		

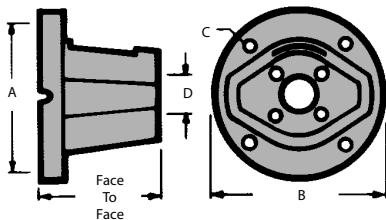

**Mount Basic Data**  
 Approximate Weight  
 Frame 49- 1 lb. 12 oz.

50	E50-A4	56C	4F17	4.40"	4.50	6.625	5.875	1.78	2.828	AC 50	3.00
	E50-AA		AA-2 Bolt					2.00	3.25		
	E50-A2	143-145 TC	A-2 Bolt					3.25	4.188		

**HORIZONTAL HYDRAULIC PUMP MOUNTS FOR ELECTRIC MOTORS "E" SERIES CONTINUED**

Frame Number	Pump Mount Part Number	Motor Frame Size	SAE Pump Flange	Face To Face	Dimensions Of NEMA-C Face Mount End (inches)			Dimensions Of Pump Face Mount End (inches)		Access Cover Number	Maximum Coupling Diameter
					A	B	Bolt Circle C	D Nominal	Pump Bolt Circle		

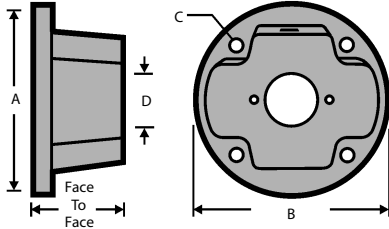

**Mount Basic Data**

Access Cover (1 required)  
 For single or light pump applications  
 Approximate Weight  
 Frame 500- 4 lb. 5 oz.

Available in 4.00 length

500	E500-A4	182-184 TC	4F17	4.188"	8.50	8.75	7.25	1.78	2.83	AC 500	4.00
	E500-AA		AA- 2 Bolt					2.00	3.25		
	E500-A2		A- 2 Bolt					3.25	4.188		
	E500-B2		B- 2 Bolt					4.00	5.75		
	E500-B4		B- 4 Bolt					4.00	5.00		

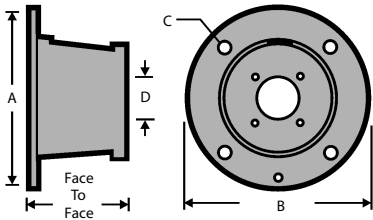

**Mount Basic Data**

502 replaces the 57Z  
 Access Cover (1 required)  
 For single or light pump applications  
 Approximate Weight  
 Frame 502- 3 lb. 7 oz.

Available in 4.75 length  
 SAE A 4 Bolt Available

502	E502-A4	182-184 TC	4F17	5.00"	8.50	8.75	7.25	1.78	2.83	AC 502	3.750
	E502-AA	213-215 TC	AA-2 Bolt					2.00	3.25		
	E502-A2	254-256 TC	A-2 Bolt					3.25	4.188		

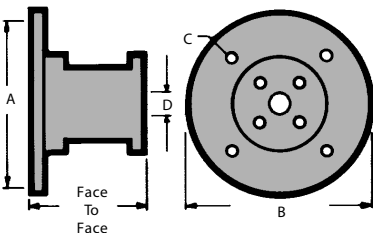

**Mount Basic Data**

Approximate Weight  
 Frame 51- 2 lb. 13 oz.  
 Frame 52- 3 lb. 7 oz.

51	E51-A4	182-184 TC	4F17	5.12"	8.50	8.75	7.25	1.78	2.83	AC 51	3.50
	E51-AA		AA-2 Bolt					2.00	3.25		
	E51-A2		A-2 Bolt					3.25	4.188		
52	E52-A4	213-215 TC	4F17	6.40"	8.50	8.75	7.25	1.78	2.828	AC 52	3.50
	E52-AA	254-256 TC	AA-2 Bolt					2.00	3.25		
	E52-A2	A-2 Bolt	3.25					4.188			

**HORIZONTAL HYDRAULIC PUMP MOUNTS FOR ELECTRIC MOTORS "E" SERIES CONTINUED**

Frame Number	Pump Mount Part Number	Motor Frame Size	SAE Pump Flange	Face To Face	Dimensions Of NEMA-C Face Mount End (inches)			Dimensions Of Pump Face Mount End (inches)		Access Cover Number	Maximum Coupling Diameter
					A	B	C	D Nominal	Pump Bolt Circle		

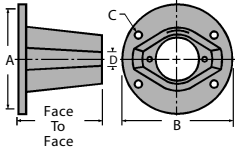

**Mount Basic Data**

Access Cover (1 required)  
 For single or light pump applications  
 Approximate Weight  
 Frame 53- 3 lb. 6 oz. – Available in 5.62 length  
 Frame 54- 3 lb. 8 oz.

Frame 55- 4 lb.  
 Frame 56- 4 lb. 2 oz.  
 Frame 57- 2 lb. 14 oz.

53	E53-A2	182-184 TC	A-2 Bolt	5.81"	8.50	8.75	7.25	3.25	4.188	AC 53	3.50
54	E54-B2		B-2 Bolt					4.00	5.75	AC54	4.00
55	E55-A2	213-215 TC	A-2 Bolt	6.81"				3.25	4.188	AC55	3.50
56	E56-B2		B-2 Bolt					4.00	5.75	AC56	4.00
57	E57-A2S	254-256 TC	A-2 Bolt	5.06"				3.25	4.188	AC57	3.50
	E57-A2L		A-2 Bolt	5.12"				3.25	4.188		

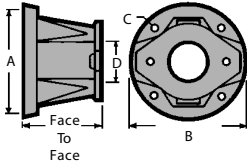

**Mount Basic Data**

Access Cover (2 required)  
 For multiple or heavy pump applications  
 Approximate Weight  
 Frame 58- 5 lb. 2 oz.  
 Frame 59- 5 lb. 7 oz.

SAE A & B Available in 4 Bolt

58	E58-A2	182-184 TC	A-2 Bolt	5.81"	8.50	8.75	7.25	3.25	4.188	AC 58	4.00
	E58-B2	213-215 TC	B-2 Bolt					4.00	5.75		
	E58-C2	254-256 TC	C-2 Bolt					5.00	7.125		
59	E59-A2	182-184 TC	A-2 Bolt	6.81"	8.50	8.75	7.25	3.25	4.188	AC 59	
	E59-B2	213-215 TC	B-2 Bolt					4.00	5.75		
	E59-C2	254-256 TC	C-2 Bolt					5.00	7.125		

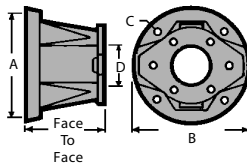

**Mount Basic Data**

Access Cover (1 required)  
 For Multiple or Heavy Pump Applications  
 Approximate Weight  
 Frame 60- 5 lb. 2 oz.  
 Frame 61- 5 lb. 7 oz.

Combination 2 & 4 Pump Flange

60	E60 A2/4	182-184 TC 213-215 TC 254-256 TC	A2/4 Bolt	5.81"	8.50	8.75	7.25	3.25	4.188	AC 60	4.50
								3.25	4.130		
61	E61 B2/4	182-184 TC 213-215 TC 254-256 TC	B2/4 Bolt	6.81"	8.50	8.75	7.25	4.00	5.75	AC 61	
								4.00	5.00		

**HORIZONTAL HYDRAULIC PUMP MOUNTS FOR ELECTRIC MOTORS "E" SERIES CONTINUED**

Frame Number	Pump Mount Part Number	Motor Frame Size	SAE Pump Flange	Face To Face	Dimensions Of NEMA-C Face Mount End (inches)			Dimensions Of Pump Face Mount End (inches)		Access Cover Number	Maximum Coupling Diameter
					A	B	Bolt Circle C	D Nominal	Pump Bolt Circle		

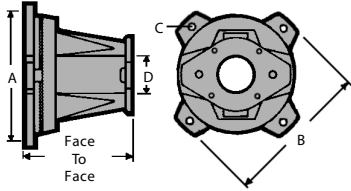

**Mount Basic Data**

Access Cover (2 required)  
 Approximate Weight  
 Frame 62- 8 lb. 2 oz.  
 Frame 63- 8 lb. 7 oz.

This mount is assembled using two parts consisting of one of frame 60 or 61 and frame 69 adapter flange.

62	E62-A2/4	284-286 TC	A-2/4 Bolt	6.87"	10.50	11.00	9.00	3.25	4.188	AC 62	4.50
	E62-B2/4		B-2/4 Bolt					4.00	5.75		
	E62-C2	C-2 Bolt	5.00					7.125			
63	E63-A2/4	284-286 TC	A-2/4 Bolt	7.87"	10.50	11.00	9.00	3.25	4.188	AC 63	
	E63-B2/4		B-2/4 Bolt					4.00	5.75		
	E63-C2	C-2 Bolt	5.00					7.125			

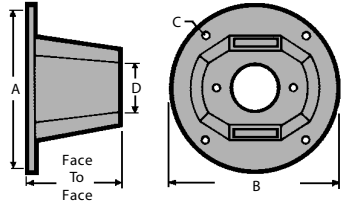

**Mount Basic Data**

Access Cover (2 required)  
 Approximate Weight  
 Frame 64- 7 lb. Available with SAE A 4 Bolt  
 Frame 65- 8 lb. 8 oz.  
 Frame 66- 10 lb. Available with SAE A 4 Bolt

64	E64-A2	324-326 TSC	A-2 Bolt	6.62"	12.50	13.00	11.00	3.25	4.188	AC 64	5.25
	E64-B2/4		B-2 Bolt					4.00	5.75		
	E64-C2/4	C-2 Bolt	5.00					7.125			
	E64-C2/4	C-4 Bolt	5.00					6.375			
65	E65-A2	324-326 TSC	A-2 Bolt	7.06"	12.50	13.00	11.00	3.25	4.188	AC 65	5.25
	E65-B2/4		B-2 Bolt					4.00	5.75		
	E65-C2/4	C-2 Bolt	5.00					7.125			
	E65-C2/4	C-4 Bolt	5.00					6.375			
66	E66-A2	324-326 TSC	A-2 Bolt	8.75"	12.50	13.00	11.00	3.25	4.188	AC 66	5.25
	E66-B2/4		B-2 Bolt					4.00	5.75		
	E66-C2/4	C-2 Bolt	5.00					7.125			
	E66-C2/4	C-4 Bolt	5.00					6.375			



**HORIZONTAL HYDRAULIC PUMP MOUNTS FOR ELECTRIC MOTORS "E" SERIES CONTINUED**

Frame Number	Pump Mount Part Number	Motor Frame Size	SAE Pump Flange	Face To Face	Dimensions Of NEMA-C Face Mount End (inches)			Dimensions Of Pump Face Mount End (inches)		Access Cover Number	Maximum Coupling Diameter
					A	B	C	D Nominal	Pump Bolt Circle		

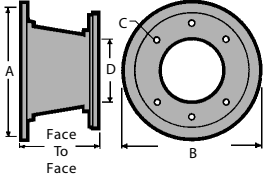

**Mount Basic Data**  
 Access Cover (2 required)  
 Approximate Weight  
 Frame 67- 12 lb. 8 oz.  
 Frame 68- 12 lb. 8 oz.

67	E67-D2/4	324-326 TSC	D-2 Bolt	7.06"	12.50	13.00	11.00	6.00	9.00	AC 67	6.00
		264-365 TSC	D-4 Bolt					6.00	9.00		
68	E68-D2/4	324-320 TSC	D-2 Bolt	8.75"	12.50	13.00	11.00	6.00	9.00	AC 68	
		264-365 TSC	D-4 Bolt					6.00	9.00		
		404-405 TSC									

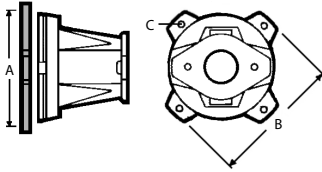

**Mount Basic Data**  
 Approximate Weight  
 Frame 69- 3 lb.

69	E69				10.50	11.00	9.00	Adapts Frames 51-61 and 501 & 502 to 284-286 TC & TSC motors			
----	-----	--	--	--	-------	-------	------	--	--	--	--

**VERTICAL (TANK TOP) HYDRAULIC PUMP MOUNTS FOR ELECTRIC MOTORS "V" SERIES**

Frame Number	Pump Mount Part Number	Motor Frame Size	SAE Pump Flange	Face To Face	Dimensions Of NEMA-C Face Mount End (inches)			Dimensions Of Pump Face Mount End (inches)	
					A	B	C	D Nominal	Pump Bolt Circle

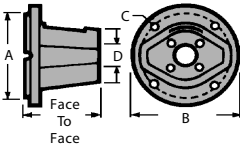

**Mount Basic Data**  
 Approximate Weight  
 Frame 70- 1 lb. 6 oz.  
 Frame 71- 1 lb. 12 oz.  
 Frame 74- 3 lb. 0 oz. (Available in 4" Lengths)

70	V70-A4	56C 143-145 TC	4F17	3.50"	4.50	6.625	5.875	1.78	2.83
	V70-AA		AA-2 Bolt					2.00	3.25
	V70-A2		A-2 Bolt					3.25	4.188
71	V71-A4	56C 143-145 TC	4F17	4.40"	4.50	6.625	5.875	1.78	2.83
	V71-AA		AA-2 Bolt					2.00	3.25
	V71-A2		A-2 Bolt					3.25	4.188
74	V74-A4	56C 143-145 TC	4F17	4.25"	8.50	8.75	7.25	1.78	2.83
	V74-AA		AA-2 Bolt					2.00	3.25
	V74-A2		A-2 Bolt					3.25	4.188

**VERTICAL (TANK TOP) HYDRAULIC PUMP MOUNTS FOR ELECTRIC MOTORS "V" SERIES CONTINUED**

Frame Number	Pump Mount Part Number	Motor Frame Size	SAE Pump Flange	Face To Face	Dimensions Of NEMA-C Face Mount End (inches)			Dimensions Of Pump Face Mount End (inches)	
					A	B	Bolt Circle C	D Nominal	Pump Bolt Circle

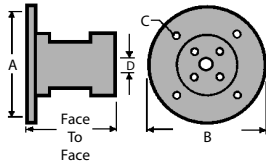

**Mount Basic Data**  
 Approximate Weight  
 Frame 72- 2 lb. 14 oz.  
 Frame 73- 3 lb. 5 oz.

SAE A 4 Bolt Available

72	V72-A4	182-184 TC	4F17	5.12"	8.50	8.75	7.25	1.78	2.83
	V72-AA	213-215 TC	AA-2 Bolt					2.00	3.25
	V72-A2	254-256 TC	A-2 Bolt					3.25	4.188
73	V73-A4	182-184 TC	4F17	6.40"	8.50	8.75	7.25	1.78	2.83
	V73-AA	213-215 TC	AA-2 Bolt					2.00	3.25
	V73-A2	254-256 TC	A-2 Bolt					3.25	4.188

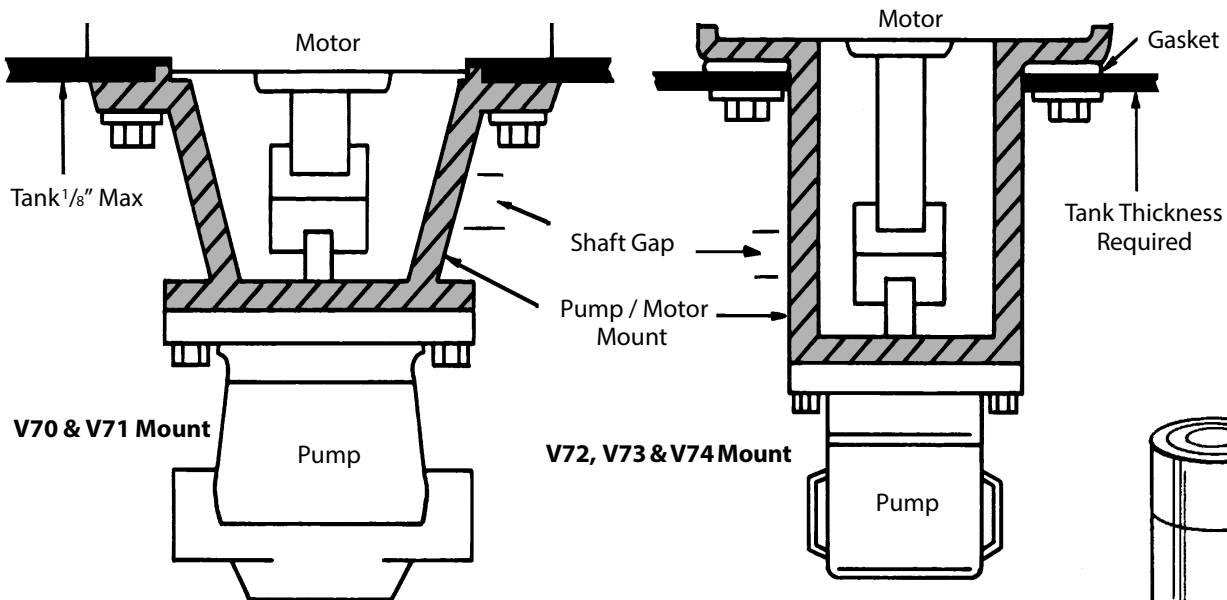

**Mounts offer easy assembly of pump to vertical motor**

Vertical pump mounts allow pump/motor assembly to be directly mounted to reservoir.

Pump coupling and shafts are within reservoir for enclosed, quiet operation.

Faster assembly of equipment with this accurately machined, aluminum casting.

**Note:**

Outside diameter of pilot on vertical V70 & V71 mounts is 4<sup>7</sup>/<sub>8</sub>".

Outside diameter of pilot on vertical V72 & V73 mounts is 5<sup>3</sup>/<sub>4</sub>", 5" on V74.

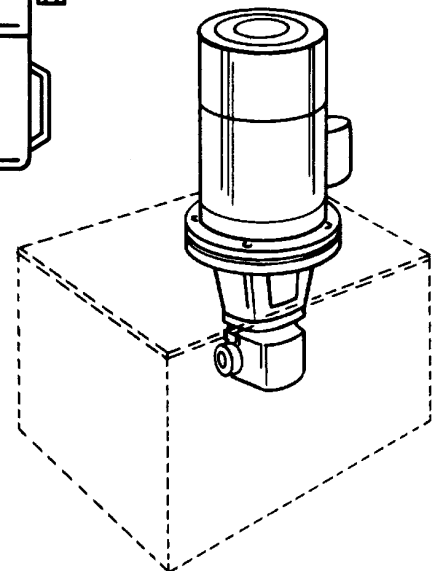

**VERTICAL ADAPTER RINGS**

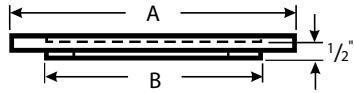

Vertical adapter rings are offered to enable standard horizontal mounts to be used for vertical tank mounts.  
 Material - Aluminum alloy

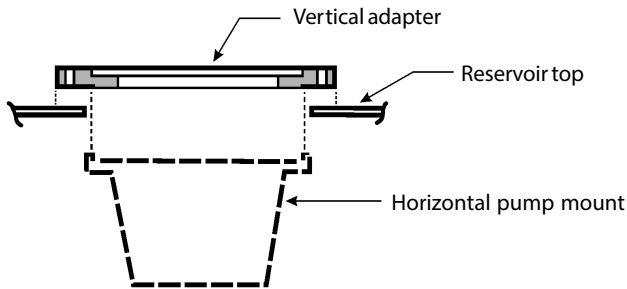
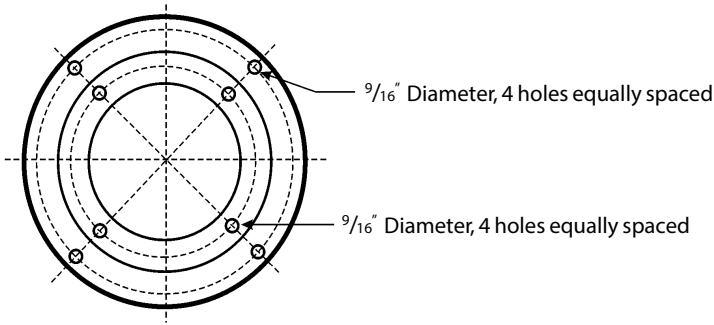

Part Number	Motor Frame	A	B	C	D	Tank Opening
1101	182 TC - 256 TC	11 1/2" Diameter	8 1/2" Diameter	10 1/4" Bolt Circle	7 1/4" Bolt Circle	9" Diameter
1102	284 TC - 286 TC	13 1/2" Diameter	10 1/2" Diameter	12 1/2" Bolt Circle	9" Bolt Circle	11 1/4" Diameter

**ASSEMBLY AID**

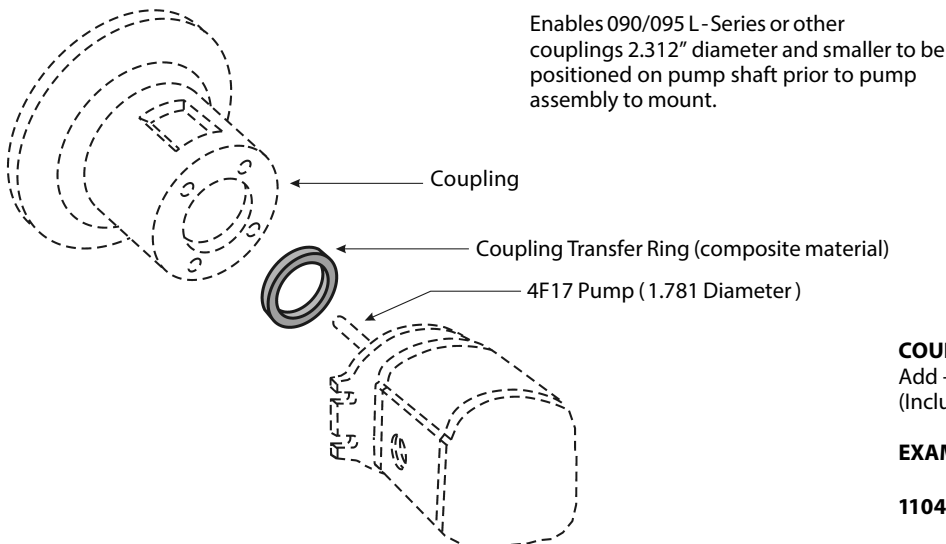

Enables 090/095 L-Series or other couplings 2.312" diameter and smaller to be positioned on pump shaft prior to pump assembly to mount.

**COUPLING TRANSFER RING**  
 Add - 015 to part number (special modification)  
 (Includes ring and machining to accommodate)

**EXAMPLE:** G15 - 117 - 5.62 - 012

**1104** Ring part number (for replacement)

**SAE-2 BOLT MOUNT**

Mounting Flange	Pilot Dimensions	Flange Dimensions	
		K	M
SAE	A		

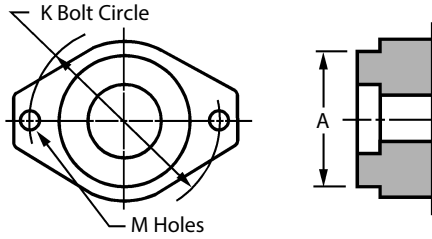

AA	2.000/1.998	3.255	0.406
		3.245	
A	3.250/3.248	4.192	0.438
		4.182	
B	4.000/3.998	5.755	0.562
		5.745	
C	5.000/4.998	7.130	0.687
		7.120	
D	6.000/5.998	9.005	0.812
		8.995	
E	6.500/6.498	12.503	1.062
		12.495	
F	7.000/6.998	13.786	1.062
		13.776	

**SAE-4 BOLT MOUNT**

Mounting Flange	Pilot Dimensions	Flange Dimensions	
		S	R
SAE	A		

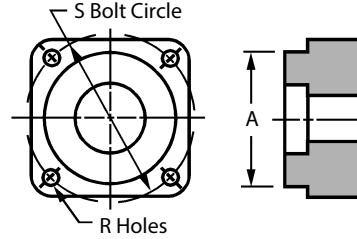

USA 4F17	1.781/1.779	2.843	0.375
		2.833	
A	3.250/3.248	4.130	0.438
		4.120	
B	4.000/3.998	5.005	0.562
		4.995	
C	5.000/4.998	6.380	0.562
		6.370	
D	6.000/5.998	9.005	0.812
		8.995	
E	6.500/6.498	12.505	1.812
		12.495	
F	7.000/6.998	13.786	1.062
		13.776	

**NEMA ELECTRIC MOTOR SHAFT AND "C" FACE**

NEMA Motor	Frame	Bolt Circle AJ	Register AK	Shaft Diameter U	Shaft Length AH	Key Sq. KF	Key Length	BF (Tapped Holes)	
								Size	No. Req'd

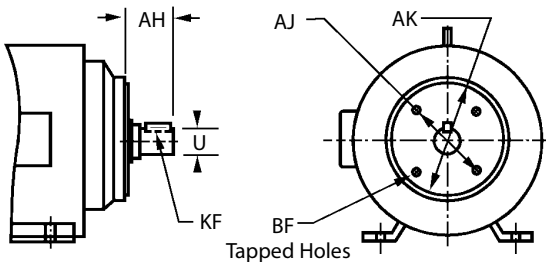

56C	5-7/8	4-1/2	5/8	2-1/16	3/16	1	3/8-16	4
143TC	5-7/8	4-1/2	7/8	2-1/8	3/16	1-3/8	3/8-16	4
145TC	5-7/8	4-1/2	7/8	2-1/8	3/16	1-3/8	3/8-16	4
182TC	7-1/4	8-1/2	1-1/8	2-5/8	1/4	1-3/4	1/2-13	4
184TC	7-1/4	8-1/2	1-1/8	2-5/8	1/4	1-3/4	1/2-13	4
213TC	7-1/4	8-1/2	1-3/8	3-1/8	5/16	2-3/8	1/2-13	4
215TC	7-1/4	8-1/2	1-3/8	3-1/8	5/16	2-3/8	1/2-13	4
254TC	7-1/4	8-1/2	1-5/8	3-3/4	3/8	2-7/8	1/2-13	4
256TC	7-1/4	8-1/2	1-5/8	3-3/4	3/8	2-7/8	1/2-13	4
284TC	9	10-1/2	1-7/8	4-3/8	1/2	3-1/4	1/2-13	4



We've Got Connections

POWER  
 TRANSMISSION  
 PRODUCTS

**NEMA ELECTRIC MOTOR SHAFT AND "C" FACE CONTINUED**

NEMA		Bolt Circle AJ	Register AK	Shaft Diameter U	Shaft Length AH	Key Sq. KF	Key Length	BF (Tapped Holes)	
Motor	Frame							Size	No. Req'd
284 TSC	286TC	9	10-1/2	1-5/8	3	3/8	1-7/8	1/2-13	4
286TSC	324TC	9	10-1/2	1-5/8	3	3/8	1-7/8	1/2-13	4
324TSC		11	12-1/2	2-1/8	5	1/2	3-7/8	5/8-11	4
		11	12-1/2	1-7/8	3-1/2	1/2	2	5/8-11	4
	326TC	11	12-1/2	2-1/8	5	1/2	3-7/8	5/8-11	4
326TSC	364TC	11	12-1/2	1-7/8	3-1/2	1/2	2	5/8-11	4
364TSC	365TC	11	12-1/2	2-3/8	5-5/8	5/8	4-1/4	5/8-11	4
		11	12-1/2	1-7/8	3-1/2	1/2	2	5/8-11	4
		11	12-1/2	2-3/8	5-5/8	5/8	4-1/4	5/8-11	4
365TSC	404TC	11	12-1/2	1-7/8	3-1/2	1/2	2	5/8-11	4
		11	12-1/2	2-7/8	7	3/4	5-5/8	5/8-11	4
404TSC	405TC	11	12-1/2	2-1/8	4	1/2	2-3/4	5/8-11	4
		11	12-1/2	2-7/8	7	3/4	5-5/8	5/8-11	4
405TSC		11	12-1/2	2-1/8	4	1/2	2-3/4	5/8-11	4